

FUTRUS® OCCASIONAL TABLES

FUTRUS
SOLUTIONS WITH DUPONT™ CORIAN®

SPECIFICATION SHEET CYLINDER TABLES



Corian.
SOLID SURFACE

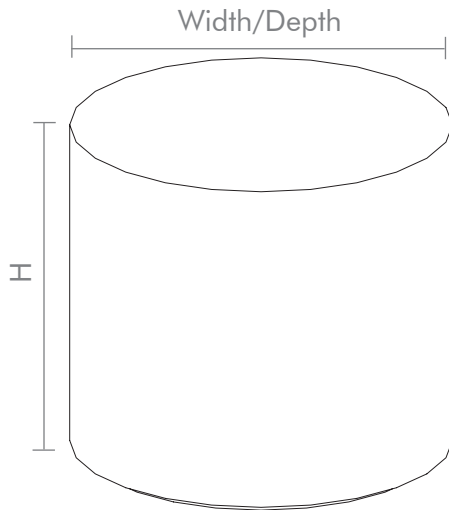

STANDARD FEATURES

- Seamless Corian® solid surface construction
- Matte Finish
- Furniture glides

OPTIONAL FEATURES

- Semi-gloss finish
- Advanced technology integration, including power/data grommets
- Integration of DuPont™ Corian® Charging Surface

- _SG Semi-gloss finish
- _PG Power grommet
- _CS Charging Surface

STANDARD COLOR OFFERINGS

- _00 Glacier White
- _01 Cameo White
- _02 Bisque
- _03 Bone
- _04 Vanilla

Additional colors available, contact Futrus®

MODEL	DIMENSIONS			WEIGHT
FCL_18	18" W	18" D	18" H	30 lbs
FCL_20	20" W	20" D	18" H	37 lbs
FCL_24	24" W	24" D	18" H	46 lbs
FCL_2424	24" W	24" D	24" H	56 lbs
FCL_30	30" W	30" D	18" H	68 lbs

CUSTOM

EXAMPLE MODEL SPECIFICATION

F	C	L	_	2	4	2	4	_	0	0	_	S	G
Model#	Width		Height	Color		Optional Upgrades							

futrus.com
info@futrus.com
1.877.FUTRUS1 (388.7871)

FUTRUS® OCCASIONAL TABLES

SPECIFICATION SHEET CUBE TABLE



Corian.
SOLID SURFACE

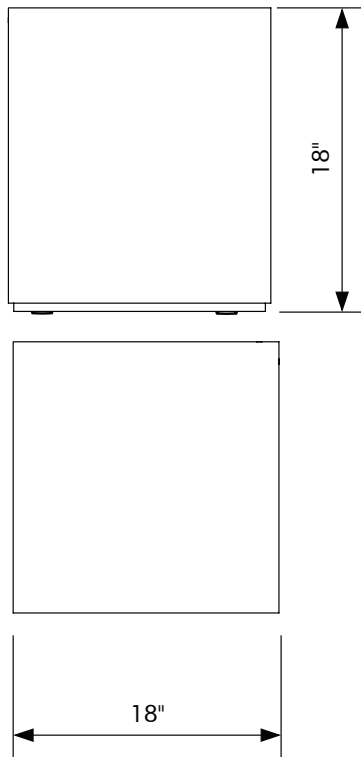

STANDARD FEATURES

- Seamless Corian® solid surface construction
- Matte Finish
- Furniture glides

OPTIONAL UPGRADES

- Semi-gloss finish
- Advanced technology integration, including power/data grommets
- Integration of DuPont™ Corian® Charging Surface

- _SG Semi-gloss finish
- _PG Power grommet
- _CS Charging Surface

STANDARD COLOR OFFERINGS

- _00 Glacier White
- _01 Cameo White
- _02 Bisque
- _03 Bone
- _04 Vanilla

Additional colors available, contact Futrus®

MODEL	DIMENSIONS			WEIGHT
FCUBE_18	18" W	18" D	18" H	27 lbs
FCUBE_ SELF-SPEC	__" W	__" D	__" H	

EXAMPLE MODEL SPECIFICATION

F	C	U	B	E	_	1	8	_	0	0	_	S	G
Model#					Color				Optional Upgrades				

SELF-SPECIFICATION EXAMPLE MODEL SPECIFICATION

F	C	U	B	E	_							_	0	0	_	S	G
Model#					Width	Depth	Height	Color				Optional Upgrades					

futrus.com
info@futrus.com
1.877.FUTRUS1 (388.7871)

FUTRUS® OCCASIONAL TABLES

FUTRUS
SOLUTIONS WITH DUPONT™ CORIAN®

SPECIFICATION SHEET TEARDROP TABLE



Corian.
SOLID SURFACE

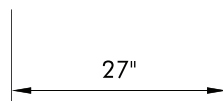
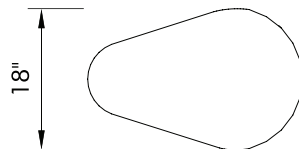
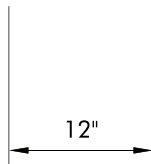
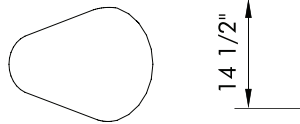
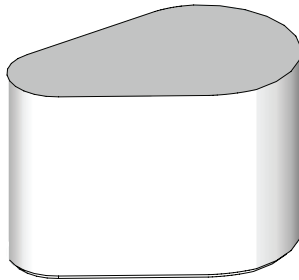

STANDARD FEATURES

- Seamless Corian® solid surface construction
- Matte Finish
- Furniture glides

OPTIONAL FEATURES

- Semi-gloss finish
- Advanced technology integration, including power/data grommets
- Integration of DuPont™ Corian® Charging Surface

_SG Semi-gloss finish

_PG Power grommet

_CS Charging Surface

STANDARD COLOR OFFERINGS

_00 Glacier White

_01 Cameo White

_02 Bisque

_03 Bone

_04 Vanilla

Additional colors available, contact Futrus®

MODEL	DIMENSIONS			WEIGHT
FTEAR_12	14½" W	12" D	18" H	20 lbs
FTEAR_27	18" W	27" D	18" H	37 lbs

EXAMPLE MODEL SPECIFICATION

F	T	E	A	R	_	2	7	_	0	0	_	S	G
Model#					Color			Optional Upgrades					

futrus.com
info@futrus.com
1.877.FUTRUS1 (388.7871)

FUTRUS® OCCASIONAL TABLES

SPECIFICATION SHEET OVAL TABLES | SMALL

FUTRUS
SOLUTIONS WITH DUPONT™ CORIAN®



Corian.
SOLID SURFACE

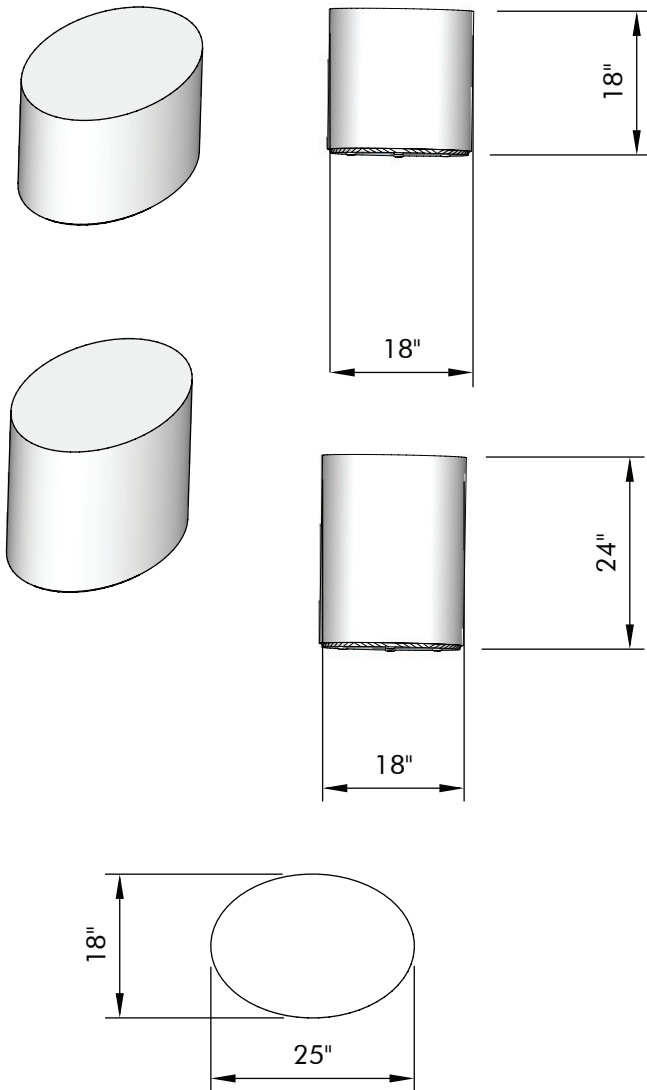

STANDARD FEATURES

- Seamless Corian® solid surface construction
- Matte Finish
- Furniture glides

OPTIONAL UPGRADES

- Semi-gloss finish
- Advanced technology integration, including power/data grommets
- Integration of DuPont™ Corian® Charging Surface

- _SG Semi-gloss finish
- _PG Power grommet
- _CS Charging Surface

STANDARD COLOR OFFERINGS

- _00 Glacier White
- _01 Cameo White
- _02 Bisque
- _03 Bone
- _04 Vanilla

Additional colors available, contact Futrus®

MODEL		DIMENSIONS			WEIGHT
FOVAL_18	SMALL	25" W	18" D	18" H	48 lbs
FOVAL_1824	SMALL TALL	25" W	18" D	24" H	60 lbs

EXAMPLE MODEL SPECIFICATION

F	O	V	A	L	-	1	8	-	0	0	-	S	G
Model#							Color			Optional Upgrades			

futrus.com
info@futrus.com
1.877.FUTRUS1 (388.7871)

FUTRUS® OCCASIONAL TABLES

SPECIFICATION SHEET

OVAL TABLES | MEDIUM/LARGE



Corian.
SOLID SURFACE

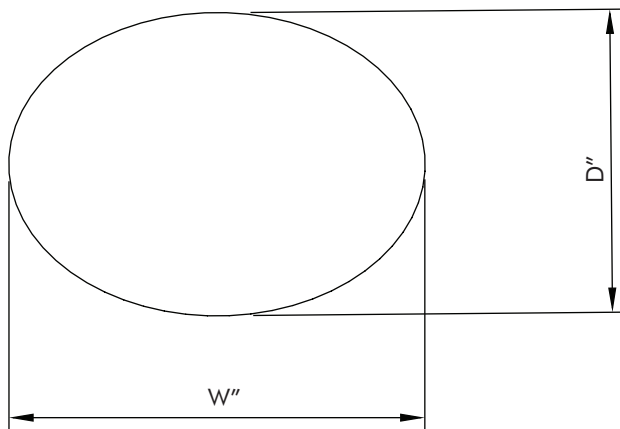
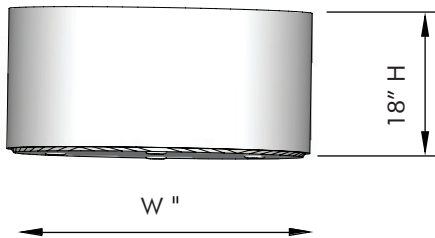
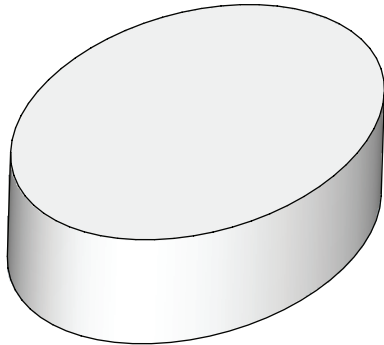

STANDARD FEATURES

- Seamless Corian® solid surface construction
- Matte Finish
- Furniture glides

OPTIONAL UPGRADES

- Semi-gloss finish
- Advanced technology integration, including power/data grommets
- Integration of DuPont™ Corian® Charging Surface

- _SG Semi-gloss finish
- _PG Power grommet
- _CS Charging Surface

STANDARD COLOR OFFERINGS

- _00 Glacier White
- _01 Cameo White
- _02 Bisque
- _03 Bone
- _04 Vanilla

Additional colors available, contact Futrus®

MODEL		DIMENSIONS			WEIGHT
FOVAL_46	MEDIUM	46" W	34" D	18" H	115 lbs
FOVAL_52	LARGE	52" W	38" D	18" H	155 lbs

EXAMPLE MODEL SPECIFICATION

F	O	V	A	L	-	4	6	-	0	0	-	S	G
Model#					Color					Optional Upgrades			

futrus.com
info@futrus.com
1.877.FUTRUS1 (388.7871)