

FUTRUS® INFINITI SHOWER NICHE

CORIAN® SHOWER NICHE WITH SEAMLESSLY INTEGRATED SHELF

FUTRUS®
SOLUTIONS WITH CORIAN® DESIGN

designed with

CORIAN®
SOLID SURFACE

MODEL FSNICHE

Specification Sheet

Division 22 Plumbing Manufacturers







FEATURES

- Made with Corian®
- Seamless & bleach cleanable
- GREENGUARD® Certified to resist mold, virus & bacteria growth
- Low maintenance
- Impact & chip resistant
- Easy Installation



• Infiniti Shower Niche - Drop-In

STANDARD CORIAN® COLOR OPTIONS

Color*	Code	Description
	00	Glacier White
	01	Cameo White
	02	Bisque
	03	Bone
	04	Silver Gray
	05	Vanilla

Color tiles are for reference only*
See full Corian® color choices at Futrus.com

CERTIFICATIONS

- Complies with the requirements in CSA B45.5/IAPMO Z124 standard for plastic plumbing fixtures and the requirements in the HUD Use of Materials Bulletin No. 73a.
- NSF/ANSI Standard 51 certified
- GREENGUARD certified to resist the growth of viruses, bacteria & mold
- GREENGUARD Gold low VOC emissions
- Contributes to LEED certification credits
- Class 1 (Class A) fire rated

FUTRUS® INFINITI SHOWER NICHE CORIAN® SHOWER NICHE WITH SEAMLESSLY INTEGRATED SHELF

FUTRUS®
SOLUTIONS WITH CORIAN® DESIGN

designed with

CORIAN®
SOLID SURFACE

MODEL FSNICHE

Specification Sheet

Division 22 Plumbing Manufacturers

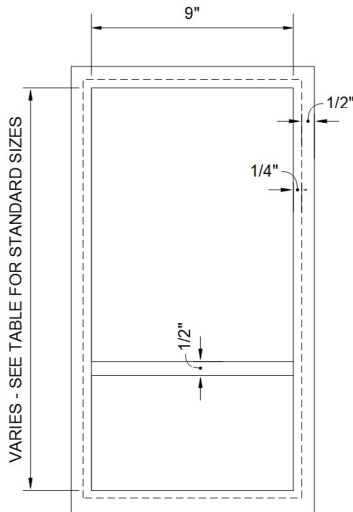

Front Elevation - Drop-In

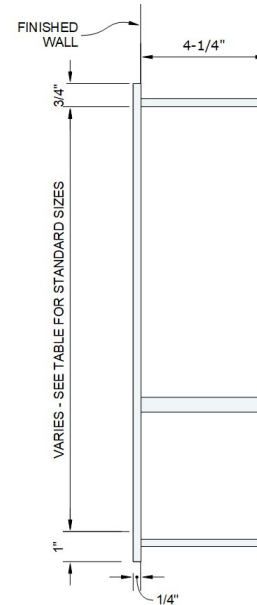

Side Section

STANDARD SIZES

Dimensions (Inches)

Code	Length	Width	Depth
FSNICHE_14	14"	9"	4-1/4"
FSNICHE_24	24"	9"	4-1/4"
FSNICHE_27	27"	9"	4-1/4"
FSNICHE_30	30"	9"	4-1/4"
CUSTOM			

RECOMMENDED SPECIFICATION

To be specified in Division 22 Plumbing

Manufacturers. The Futrus Infiniti Shower Niche, Model FSNICHE. Niche to be made of 100% acrylic Corian® solid surface with no polyester blends. Must comply with the requirements in CSA B45.5/IAPMO Z124 standard for plastic plumbing fixtures and the requirements in the HUD Use of Materials Bulletin No. 73a. Shower base and walls to be NSF/ANSI Standard 51 certified; GREENGUARD certified to resist the growth of viruses, bacteria & mold; GREENGUARD Gold low VOC emissions; Contribute to LEED certification credits; Class 1 (Class A) fire rated.

TECHNICAL INFORMATION

- All dimensions are nominal
- Futrus® 1-year limited warranty
- Corian® 10-year material warranty

EXAMPLE MODEL SPECIFICATION

FSNICHE_14_GLACIERWHITE
(Model_Length_Corian Color)